

PEREBO float PT04

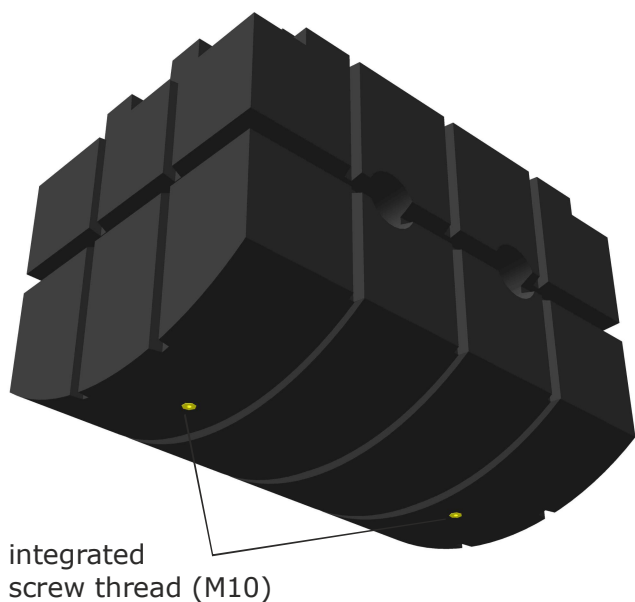

technical data	
dimensions L/W/H:	115,0 / 78,0 / 77,0cm
wall thickness :	approx. 8mm
self-weight:	approx. 36kg
material:	polyethylene
screw threads M10:	6x (4 above, 2 below)
standard color:	black
(other colors on request)	

load capacity (approx. values)	
immersion depth [cm]	load capacity [kg]
5,0	-16,0
10,0	18,0
15,0	62,0
20,0	107,0
25,0	151,0
30,0	196,0
35,0	238,0
38,5	262,8
40,0	271,0
45,0	305,0
50,0	349,0
57,0	411,0
(self-weight deducted)	
1/2 immersion depth= 38,5cm	
max. recommended immersion depth= 57cm	

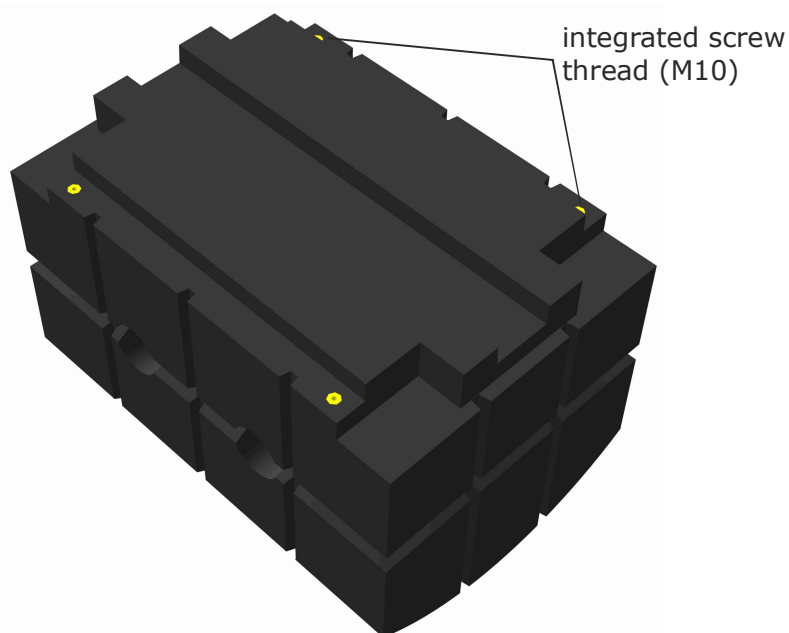